

## GS/L RA 25S4 1150X685

EASY TO MOVE



### LIFTER GS PRO

The GS PRO Series is an excellent tool for lifting and carrying loads on pallets or size-standardised containers, thanks to its lightweight, smooth movement and manoeuvrability.



### HYDRAULIC UNIT

Resistant and reliable one piece cast iron pump, worked with numerical control machine, including:

- **MAXIMUM PRESSURE VALVE:** safety device that ensures the transpallet against overloads. When the pressure inside the hydraulic circuit exceeds the set calibration value according to the maximum nominal flow, the valve automatically locks the forks.
- **PROPORTIONAL LOWERING VALVE:** lowering speed can be proportionally controlled according to the lever position on the tiller. Perfect working tool to carry fragile and delicate loads like crystal, glass and ceramics.



### VARNISHING

Following an appropriate conditioning operation the frame is varnished with polyester powder at a temperature of 250° to guarantee maximum resistance to wear and atmospheric agents.



## Descriere

1.1 Producător			LIFTER
1.3 Comandă			Manual
1.4 Poziție operare			Pedestru
1.5 Capacitate maximă	Q	Kg	2500
1.6 Distanța la centrul de aplicare al sarcinii	c	mm	600
1.8 Sarcina de la osie la capătul furcilor	x	mm	932
1.9 Ampatament	y	mm	1192

## Greutăți

2.1 Greutate de operare		Kg	68
2.2 Sarcină osie, încărcare pe spate		Kg	1797
2.2 Sarcină osie, încărcare pe față		Kg	771
2.3 Sarcină osie, liber spate		Kg	22
2.3 Sarcină osie, liber față		Kg	46

## Cauciucuri/Șasiuri

3.2 Mărime cauciuc: roți direcție - Diametru		mm	200
3.2 Mărime cauciuc: roți direcție - Lățime		mm	55
3.3 Mărime cauciuc: transportoare cu role - Diametru		mm	82
3.3 Mărime cauciuc: transportoare cu role - Lățime		mm	60
3.5 Dimensiune cauciuc: roți spate		nr	4
3.5 Ax de echilibru spate			No
3.6 Ecartament, față	b10	mm	155
3.7 Ecartament, spate	b11	mm	535

## Dimensiuni

4.4 Înălțime stivuitor	h3	mm	115
4.9 Înălțime manetă în poziția de deplasare, max	h14	mm	1160
4.15 Înălțime, coborât	h13	mm	85
4.19 Lungime globală	l1	mm	1550
4.20 Distanța până la suprafața frontală a furcilor	l2	mm	400
4.21 Lățime globală	b1	mm	685
4.22 Dimensiuni furcă - grosime	s	mm	55
4.22 Dimensiuni furcă - Lățime	e	mm	150
4.22 Dimensiuni furcă - Lungime	l	mm	1150
4.25 Distanța între furci	b5	mm	685
4.32 Gardă la sol și mijloc ampatament	m2	mm	30
4.34 Lățime culoar	Ast	mm	1835
4.35 Rază de virare	Wa	mm	1367

## Performante

5.2 Viteză de ridicare, încărcat	strokes		13
5.2 Viteză de ridicare, descărcat	strokes		13

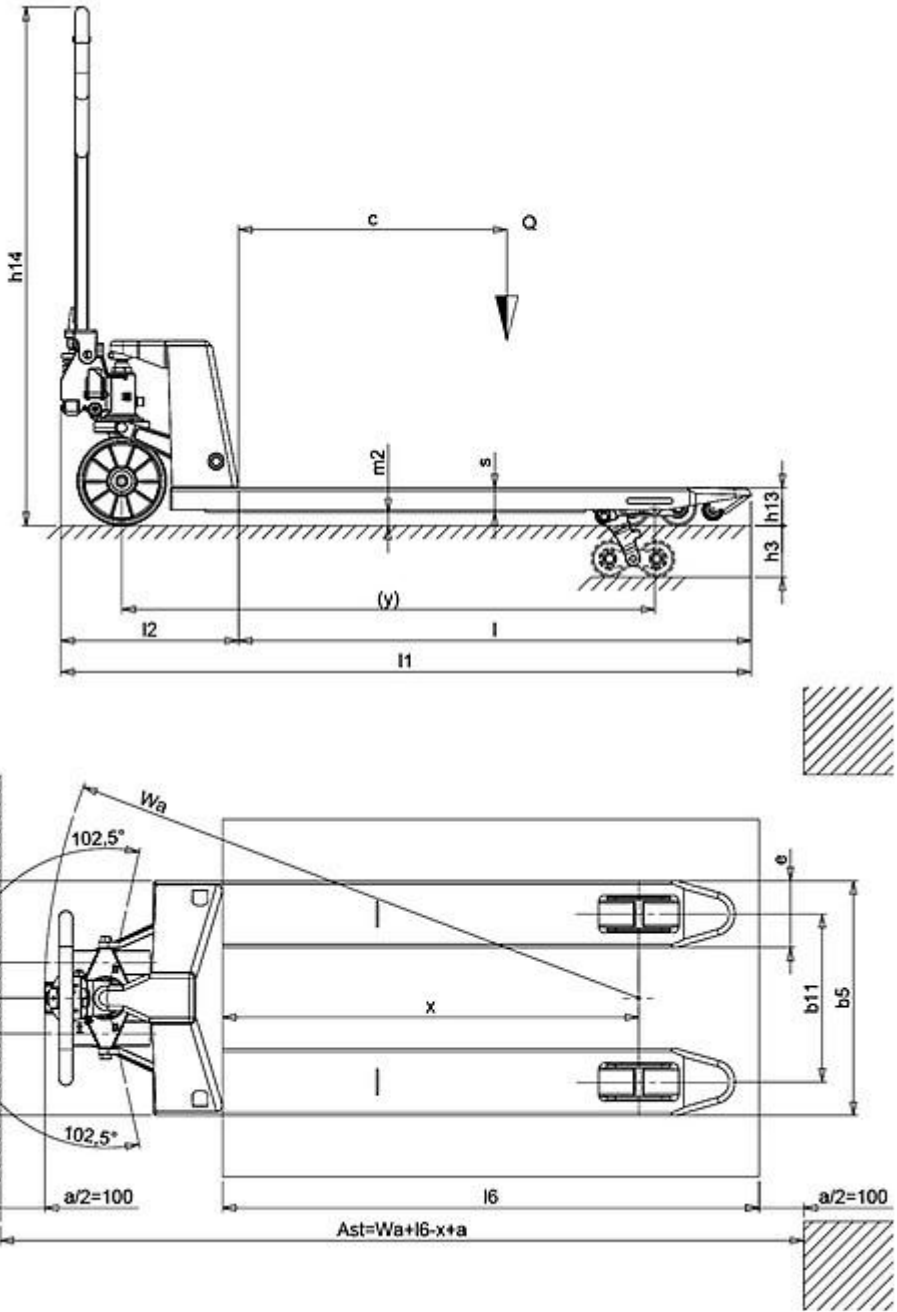

The information is aligned with the Data file at the time of download. Printed on 23/02/2020 (ID 565)

©2019 | PR INDUSTRIAL s.r.l. | All rights reserved | Image shown may not reflect actual package. Specifications subject to change without notice

